

KHB3K (BK3)

KHB3K(BK3) Two-position Three-way High Pressure Ball Valve

Model Code

KHB3K-G1/2 - 13 - L N - 1 1 1 1 - 01 - 1
 1 2 3 4 5 6 7 8 9 10 11

1. Series Code: KHB3K Two-position Three-way High Pressure Ball Valve
 2. Joint Code: G**, M**, **LR, **SR, PT**, NPT**;
 3. Nominal Diameter: 04, 06, 08, 10, 13, 16, 20, 25, 32, 40, 50, ;
 4. Ball Valve Enginery: L-L Type, T-T Type
 5. working oil port(difference between three way to straight way) Join Thread :
N-female / W-male thread.
 6. Valve body/joint material: 1-carbon steel, 3-316 stainless steel
 7. Ball body/ Valve lock material: 1-carbon steel, 3-316 stainless steel
 8. Ball Sealing material: 1-POM 2-PTFE
 9. Sealing material(linking valve body/joint/valve lock): 1-NBR 2-FPM/FKM
 10. Handle Type: 01-C type zinc alloy crooked handle 02-B type zinc alloy crooked handle
03-B type casting steel crooked handle 09-without handle
 11. Surface Treatment: 1-SILVER ZINC PLATED
- PS: The Material Pressure parameters corresponding to the product is carbon steel.
 1111 is the normal mix, the PN no more than 100bar when using PTFE.
 (other specifications please contact us)



Symbol

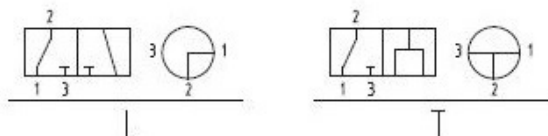

Overall Dimension

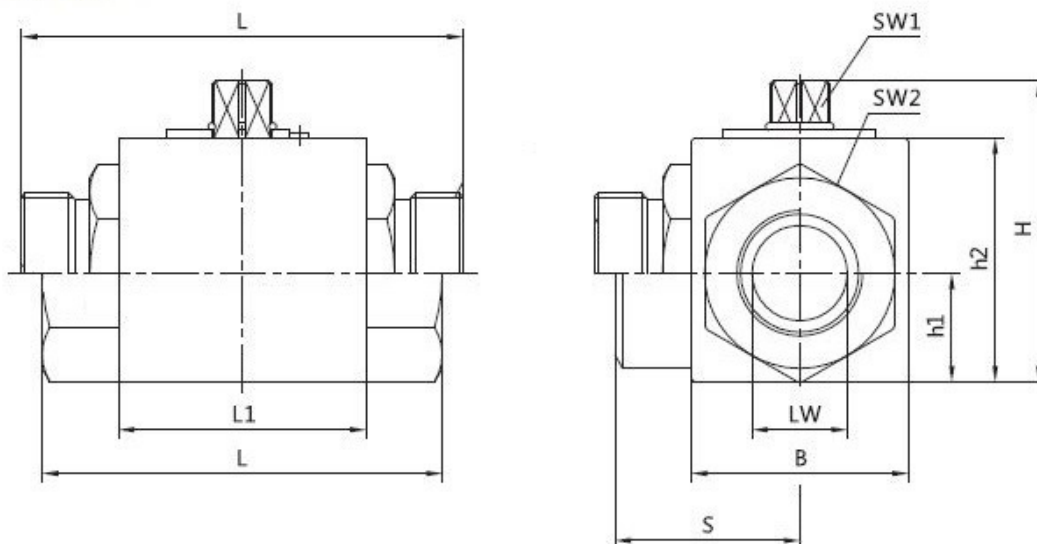

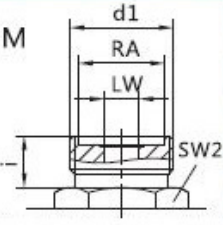
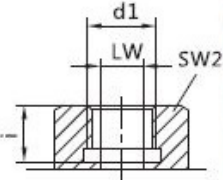
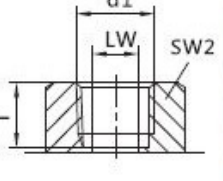
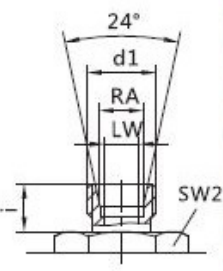
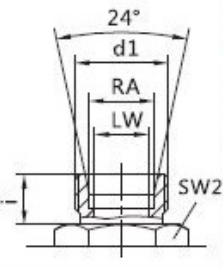
		PN (bar)	DN	LW	RA	d1	i	L	L1	B	H	h1	h2	SW1	SW2	S
M 	KHB3K-M16×1.5	500	06	06	11	M16×1.5	11	69	40	26	45	13.5	33	09	22	27.5
	KHB3K-M22×1.5	500	08	08	16	M22×1.5	12	76	42	32	49	16	36	09	27	33
	KHB3K-M27×1.5	500	10	10	20	M27×1.5	12	76	42	32	49	16	36	09	27	33
	KHB3K-M30×1.5	400	16	15	24	M30×1.5	13	84	48	38	61	19	45	09	32	37
	KHB3K-M36×2	400	20	20	30	M36×2	15	103	60	48	70	25	55	12	41	45.5
	KHB3K-M42×2	350	25	25	35	M42×2	18	116	65	57	79	28.5	64	12	50	54
	KHB3K-M52×2	350	32	30	40	M52×2	20	149	84	75	101	37.5	84	14	60	62.5
	KHB3K-M60×2	350	40	38	45	M60×2	22	174	91	85	112	42.5	95	14	70	84
G 	KHB3K-G 1/8	500	04	06		G 1/8	14	69	40	26	45	13.5	33	09	22	34.5
	KHB3K-G 1/4	500	06	06		G 1/4	14	69	40	26	45	13.5	33	09	22	34.5
	KHB3K-G 3/8	500	10	10		G 3/8	14	72	42	32	49	16	36	09	27	36
	KHB3K-G 1/2	500	13	12		G 1/2	14	83	47	35	49	18	38	09	30	34
	KHB3K-G 1/2	400	16	15		G 1/2	16	83	48	38	61	19	45	09	32	42
	KHB3K-G 3/4	400	20	20		G 3/4	18	95	60	48	70	25	55	12	41	49
	KHB3K-G 1	350	25	25		G 1	21	113	65	57	79	28.5	64	12	50	56.5
	KHB3K-G 1 1/4	350	32	30		G 1 1/4	22	110	84	75	101	37.5	84	14	60	62.5
	KHB3K-G 1 1/2	350	40	38		G 1 1/2	24	130	91	85	112	42.5	95	14	70	61
	KHB3K-G 2	350	50	48		G 2	26	140	100	104	131	52	112.5	14	90	66
NPT(PT) 	KHB3K-NPT 1/8	500	04	06		NPT 1/8	11	69	40	26	45	13.5	33	09	22	34.5
	KHB3K-NPT 1/4	500	06	06		NPT 1/4	11	69	40	26	45	13.5	33	09	22	34.5
	KHB3K-NPT 3/8	500	10	10		NPT 3/8	11	72	42	32	49	16	36	09	27	36
	KHB3K-NPT 1/2	500	13	12		NPT 1/2	14	83	47	35	49	18	38	09	30	34
	KHB3K-NPT 1/2	400	16	15		NPT 1/2	14	83	48	38	61	19	45	09	32	42
	KHB3K-NPT 3/4	400	20	20		NPT 3/4	15	95	60	48	70	25	55	12	41	49
	KHB3K-NPT 1	350	25	25		NPT 1	17	113	65	57	79	28.5	64	12	50	56.5
	KHB3K-NPT1 1/4	350	32	30		NPT1 1/4	18	110	84	75	101	37.5	84	14	60	66
	KHB3K-NPT 1 1/2	350	40	38		NPT1 1/2	18	130	91	85	112	42.5	95	14	70	61
	KHB3K-NPT 2	350	50	48		NPT 2	18	140	100	104	131	52	112.5	14	90	62.5
LR 	KHB3K-06LR	500	04	04	06	M12×1.5	10	67	40	26	45	13.5	33	09	22	33.5
	KHB3K-08LR	500	06	06	08	M14×1.5	10	67	40	26	45	13.5	33	09	22	33.5
	KHB3K-10LR	500	06	08	10	M16×1.5	11	74	40	26	45	13.5	33	09	22	36
	KHB3K-12LR	500	10	10	12	M18×1.5	11	74	42	32	49	16	36	09	27	36
	KHB3K-15LR	500	13	12	15	M22×1.5	12.5	82	47	35	53	18	38	09	30	40
	KHB3K-15LR	400	16	12	15	M22×1.5	12	82	48	38	61	19	45	09	32	40
	KHB3K-18LR	500	13	12	18	M26×1.5	12.5	82	47	35	53	18	38	09	30	42
	KHB3K-18LR	400	16	15	18	M26×1.5	12	82	48	38	61	19	45	09	32	42
	KHB3K-22LR	400	20	19	22	M30×2	14	101	60	48	70	25	55	12	41	49
	KHB3K-28LR	350	25	25	28	M36×2	14	108	65	57	79	28.5	64	12	50	54
	KHB3K-35LR	350	32	30	35	M45×2	16	141	84	75	101	37.5	84	14	60	66
	KHB3K-42LR	350	40	36	42	M52×2	16	162	91	85	112	42.5	95	14	70	78
SR 	KHB3K-08SR	500	04	05	08	M16×1.5	12	73	40	26	45	13.5	33	09	22	34.5
	KHB3K-10SR	500	06	06	10	M18×1.5	12	73	40	26	45	13.5	33	09	22	34.5
	KHB3K-12SR	500	08	08	12	M20×1.5	12	76	40	26	45	13.5	33	09	22	36
	KHB3K-14SR	500	10	10	14	M22×1.5	14	80	42	32	49	16	36	09	27	36
	KHB3K-16SR	500	13	12	16	M24×1.5	14	86	47	35	53	18	38	09	30	44
	KHB3K-16SR	400	16	13	16	M24×1.5	14	86	48	38	61	19	45	09	32	37
	KHB3K-20SR	500	13	12	20	M30×2	16	90	47	35	53	18	38	09	30	44
	KHB3K-20SR	400	16	15	20	M30×2	16	90	48	38	61	19	45	09	32	37
	KHB3K-25SR	400	20	20	25	M36×2	18	109	60	48	70	25	55	12	41	49
	KHB3K-30SR	350	25	25	30	M42×2	20	120	65	57	79	28.5	64	12	50	60
KHB3K-38SR	350	32	30	38	M52×2	22	153	84	75	101	37.5	84	14	60	76.5	