



FA1 SERIES

In line spin-on type filters

Inline filters with spin-on cartridge, suitable for use on suction, return or low pressure line.

Available with or without bypass, indicator port is a standard option to fit a visual or electrical indicator.



HOUSING

tested according to NFPA T3.10.17, ISO12829, ISO3968

PRESSURE: Max operating: 12 bar
Burst: 20 bar

CONNECTIONS: G 3/4" ÷ G 1 1/2"

MATERIALS: Head: aluminium alloy
Bowl: painted steel
Seal: NBR

BYPASS VALVE: No by-pass (max work pressure 5 bar)
0,25 bar setting (SUCTION)
1,7 bar setting (RETURN/IN LINE)

ELEMENT

tested according to ISO 11170, 2941, 2942, 2943, 3724, 3968, 16889, 16908, 23181

FILTER MEDIA: Inorganic microfiber:
G03 - G06 - G10 - G25
Paper:
C10 - C25
Wire mesh:
T60 - T125

COLLAPSE PRESSURE: 5 bar

TEMPERATURE RANGE: from -30 °C to +100 °C

FLUID COMPATIBILITY: Full with HH-HL-HM-HV
HETG-HEES (acc. to ISO 6743/4).
For use with other fluid please
contact Filtrtec Customer Service
(info@filtrtec.it).

OVERALL DIMENSIONS

FA1-10/11

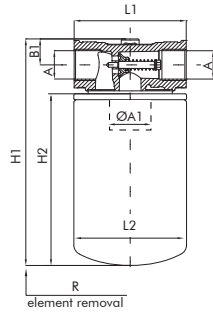

FA1-20/21/22

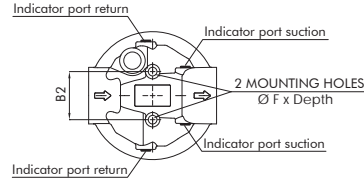
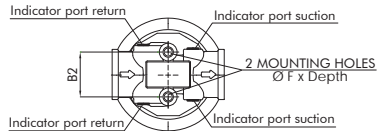
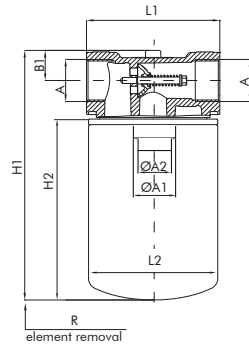

FA1 30/31/32

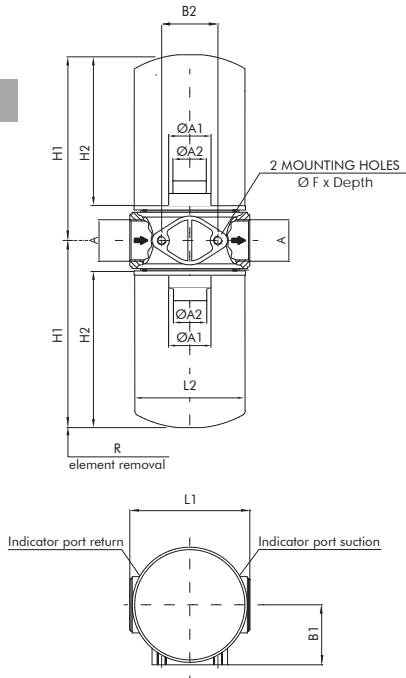

FA1 40/41/42

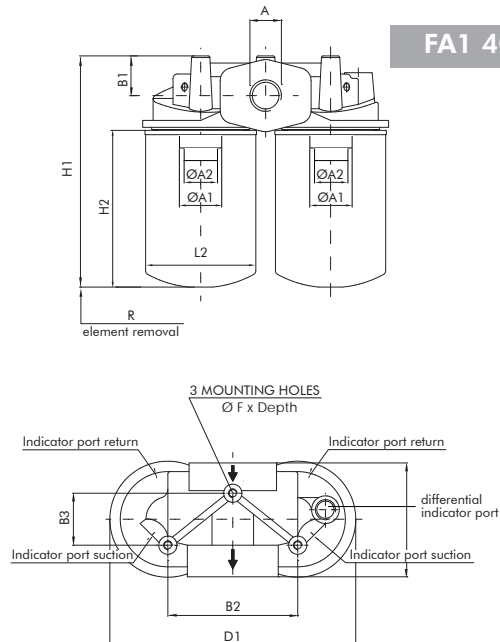

NOMINAL SIZE

CODE	A	A1	A2	B1	B2	B3	D1	F	H1	L1	R	WEIGHT ELEMENT	H2	L2	
FA1-10	G 3/4"	G 3/4"	---	22	38	---	---	M8x15	192	95	20	1,3 Kg	A-1-10	148	
FA1-11									257			1,5 Kg	A-1-11	213	
FA1-20	G 1 1/4"	G 1 1/4"	1 1/2"	30	50	---	---		249	133	---	1,9 Kg	A-1-20	182	
FA1-21									295			2,2 Kg	A-1-21	228	
FA1-22								380	2,6 Kg			A-1-22	313		
FA1-30	G 1 1/2"	G 1 1/4"	1 1/2"	70	65	---	---	M10x15	218	140	40	3,5 Kg	2x A-1-20	182	
FA1-31									264			3,8 Kg	2x A-1-21	228	128
FA1-32									349			4,2 Kg	2x A-1-22	313	
FA1-40	G 1 1/2"	G 1 1/4"	1 1/2"	46	150	60	284		267	132	---	5,0 Kg	2x A-1-20	182	
FA1-41								313	5,2 Kg			2x A-1-21	228		
FA1-42								398	5,6 Kg			2x A-1-22	313		

ORDERING INFORMATION

1.	2.	3.	4.	5.	6.	7.	8.
F	A1	21	G10	B	B6	R	MPB
SPARE ELEMENT	A1	21	G10				

1. FILTER SERIES	F		
2. FILTER ELEMENT SERIES	A1		
3. FILTER SIZE	10-11		
	20-21-22		
	30-31-32	fit 2 elements A120-A121-A122	
	40-41-42	fit 2 elements A120-A121-A122	
4. FILTER MEDIA	000	no element	
	C10	paper $\beta_{10\mu m(c)} > 2$	
	C25	paper $\beta_{25\mu m(c)} > 2$	
	G03	glassfiber $\beta_{5\mu m(c)} > 1.000$	
	G06	glassfiber $\beta_{7\mu m(c)} > 1.000$	
	G10	glassfiber $\beta_{12\mu m(c)} > 1.000$	
	G25	glassfiber $\beta_{22\mu m(c)} > 1.000$	
	T60	wire mesh 60 μm	
T125	wire mesh 125 μm		
5. SEALS	B	NBR	
6. CONNECTIONS	B4	G 3/4"	for sizes 10-11
	B6	G 1 1/4"	for sizes 20-21-22
	B7	G 1 1/2"	for sizes 30-31-32-40-41-42
	F7M	1 1/2" SAE J518-3000 psi - M12	for sizes 40-41-42
7. BYPASS VALVE	0	no by-pass	
	R	1,7 bar (return application)	
	S	0,25 bar (suction application)	
8. INDICATOR	000	no indicator	
	MPB	pressure gauge 0 ÷ 10 bar	for return application
	* PDB	pressure switch 1,3 bar SPDT	
	MPO	pressure gauge 0 ÷ 16 bar	for inline application
	MPA	pressure/vacuum gauge -1 ÷ 5 bar	for return and suction application
	MPS	vacuum gauge 0 ÷ -1 bar	for suction application
	* PDS	vacuum switch -0,2 bar	
	Z20	differential visual 1,3 bar	for size 40-41-42 inline application
	* Available also with LC24=Led connector (see clogging indicators catalogue)		

HYDRAULIC SIMBOLS

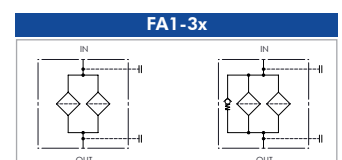
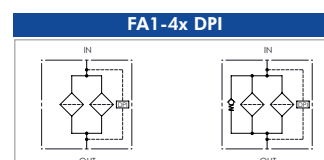
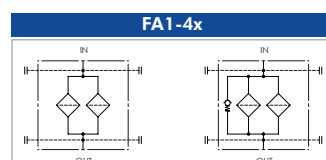
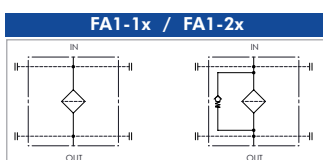

PRESSURE DROP (Δp) INFORMATION FOR FILTER SIZING

The total Delta P through a filter assembly is given from Housing Δp + Element Δp . This ideally should not exceed 0,2 bar for suction application and 0,5 bar for return (it should never exceed 1/3 of the set value of the by-pass valve). N.B. All the reported data have been obtained at our laboratory, according to specification ISO3968 with mineral oil having 32 cSt viscosity and density 0,875 Kg/dm³.

HOUSING PRESSURE DROP

The housing Δp is given by the curve of the considered model and port, in correspondence of the flow rate value.

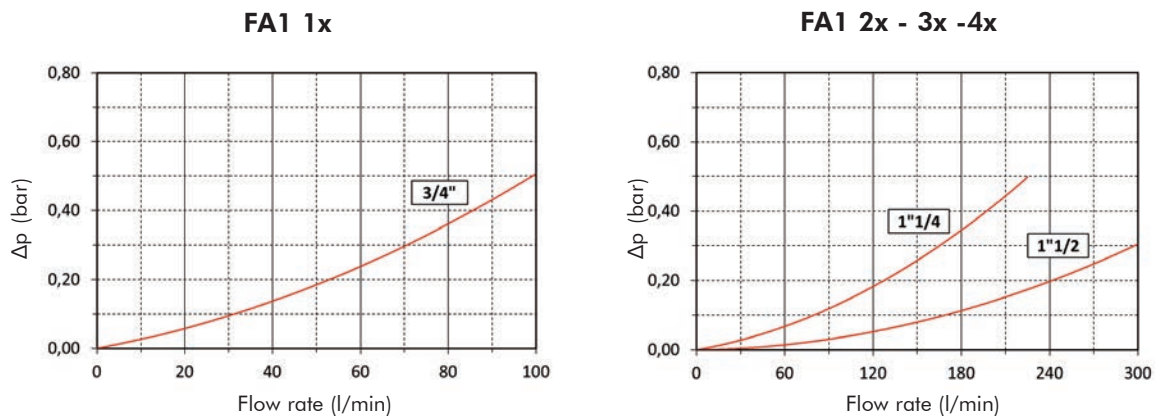

ELEMENT PRESSURE DROP

The element Δp (bar) is given by the flow rate (l/min) multiplied by the factor in the table here below corresponding to the selected media and divided by 1000. If the oil has a viscosity V_x different than 32 cSt a corrective factor $V_x/32$ must be applied.

Example: 80 l/min with A120G10 and oil viscosity 46 cSt: $(80 \times 2,33)/1000 \times (46/32) = 0,27$ bar (with FA

Example: 80 l/min with (*1) 2x A120G10 and oil viscosity 46 cSt: $(80 \times 1,17)/1000 \times (46/32) = 0,13$ bar

	C10	C25	G03	G06	G10	G25	T60	T125
A110	1,90	1,70	6,50	6,00	3,60	2,80	0,90	0,60
A111	1,60	0,90	4,30	4,00	3,40	1,60	0,50	0,25
A120	0,67	0,57	4,33	3,67	2,33	1,23	0,27	0,23
A121	0,60	0,47	3,67	2,67	2,00	1,00	0,23	0,20
A122	0,33	0,26	2,07	1,51	1,13	0,57	0,13	0,11
(*1) 2 x A120	0,34	0,29	2,17	1,84	1,17	0,62	0,14	0,12
(*2) 2 x A121	0,30	0,24	1,84	1,34	1,00	0,50	0,12	0,10
(*3) 2 x A122	0,16	0,13	1,03	0,75	0,56	0,28	0,06	0,05

(*1) values for FA130 & FA140 - (*2) values for FA131 & FA141 - (*3) values for FA132 & FA142
These sizes are fitting 2 cartridges each

EXAMPLE OF TOTAL Δp CALCULATION

FA120G10BB6RMPB with 80 l/min and oil 46 cSt:

Housing Δp 0,1 bar + element Δp 0,27 bar $(80 \times 2,33)/1000 \times (46/32) =$ total assembly Δp 0,37 bar.

FA140G10BB6RMPB with 80 l/min and oil 46 cSt:

Housing Δp 0,03 bar + element Δp 0,13 bar $(80 \times 1,17)/1000 \times (46/32) =$ total assembly Δp 0,16 bar.

BYPASS VALVE PRESSURE DROP

The bypass valve Δp is given by the curve of the considered model and setting, in correspondence of the flow rate value.

SUCTION BYPASS

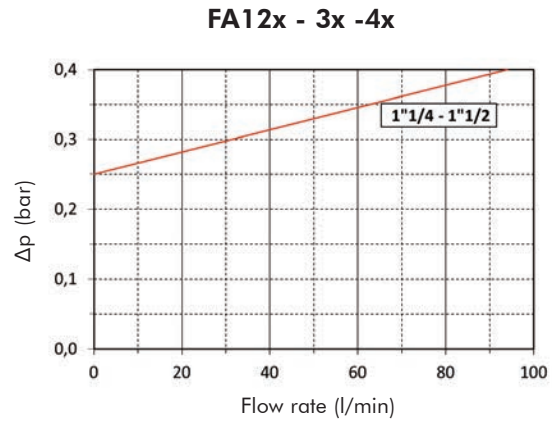
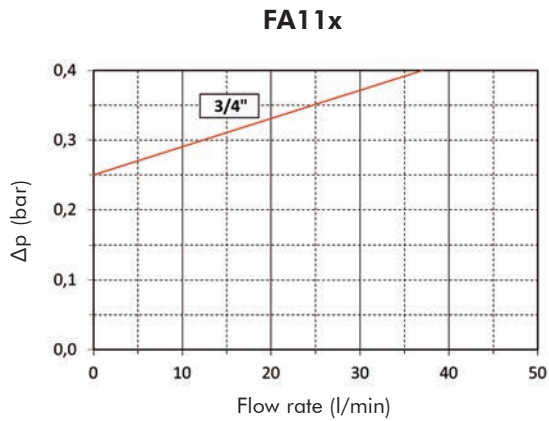

RETURN/INLINE BYPASS

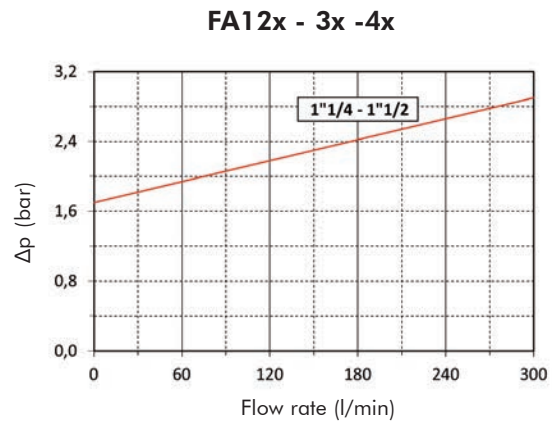
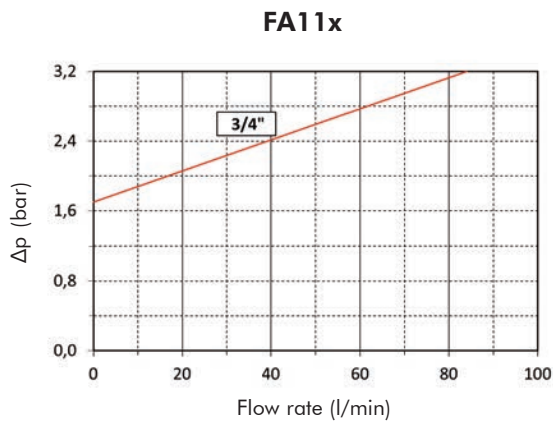

N.B. All the reported data have been obtained at our laboratory, according to specification ISO3968 with mineral oil having 32 cSt viscosity and density 0,875 Kg/dm³.

USER TIPS



CARTRIDGE TIGHTENING TORQUE

All models	3/4 turn
------------	----------

INDICATOR TIGHTENING TORQUE

MPO-MPS-MPB-MPA-PDB	10 Nm
PDS	
Z20	50 Nm



WARNING

-  Make sure that Personal Protective Equipment (PPE) is worn during installation and maintenance operation.

DISPOSAL OF FILTER ELEMENT

-  The used filter elements and the filter parts dirty of oil are classified as "Dangerous waste material": they must be disposed according to the local laws by authorized Companies.



INSTALLATION

-  1. the IN and OUT ports must be connected to the hoses in the correct flow direction (an arrow shows on the filter head (1))
2. the filter housing should be preferably mounted with the cartridge (5) downward
3. secure to the frame the filter head (1) using the threaded fixing holes (3)
4. verify that no tension is present on the filter after mounting
5. enough space must be available for filter element cartridge replacement
6. the visual clogging indicator must be in a easily viewable position
7. when a electrical indicator is used, make sure that it is properly wired
-  8. never run the system with no filter element fitted
9. keep in stock a spare FILTREC filter element for timely replacement when required

OPERATION

-  1. the filter must work within the operating conditions of pressure, temperature and compatibility given in the first page of this data sheet
2. the filter element must be replaced as soon as the clogging indicator signals at working temperature (in cold start conditions, oil temperature lower than 30°C, a false alarm can be given due to oil viscosity)
3. If no clogging indicator is mounted, replace the element according to the system manufacturer's recommendations

MAINTENANCE

-  1. make sure that the system is switched off and there is no residual pressure in the filter
2. unscrew the filter cartridge (5) by turning it anti-clockwise and remove it
3. fit a new FILTREC cartridge element (5), verifying the part number, particularly concerning the micron rating
4. ensure that the head mounting face is clean
-  5. lubricate the gasket of the replacement cartridge and the thread prior to assembly
7. spin on the new cartridge until it reaches the mounting face and tighten for 3/4 turn.

