

Filter element, two-stage

Type 73. filter elements

RE 51458

Edition: 2021-04

Replaces: -



- ▶ Size 0110 ... 0270
- ▶ Collapse pressure rating up to 30 bar [435 psi]
- ▶ Filter rating: 3 ... 10 µm
- ▶ Filter area: up to 4.8 m² [up to 7440 in²]
- ▶ Operating temperature: -10 °C ... 100 °C [14°F... 212°F]

Features

- ▶ Low initial pressure differential (ISO 3968)
- ▶ Functional filter element with two filtration stages for wind turbines
- ▶ High dirt holding capacity and filtration performance due to multi-layer glass fiber technology and simultaneously a low initial pressure differential (ISO 3968)
- ▶ Special highly efficient filter materials

Contents

Features	1
Ordering code	2
Preferred types	2
Filter design	3
Function, set-up	4
Filter variables	5
Filter media, technical data	6 ... 8
Compatibility with hydraulic fluids	8
Installation, commissioning and maintenance	9
Directives and standardization	9

Ordering code

of the type 73 filter element.

01	02	03	04	05	06	07
73.			-	A	00	- 0 - M

Filter element

01	Design	73.
----	--------	-----

Size

02	According to Hengst standard	0110
		0120
		0135
		0145
		0200
		0270

Filter rating in µm

03	Filter element	1st stage	= main filter, non-woven glass fiber media, absolute (ISO 16889)	H3XL	
				H6XL	
				PWR10	
		2nd stage		= protective filter, stainless steel wire mesh	G25
					G40

Pressure differential

04	Max. admissible pressure differential of the filter element 30 bar [435 psi]	A
----	--	---

Element design

05	Standard adhesive	0...
	Standard material	... 0

Bypass valve

06	With filter element always 0	0
----	------------------------------	---

Seal

07	NBR seal	M
----	----------	---

Order example:

73.0110 PWR10/G40-A00-0-M

Material no.: R928047823

Preferred types**Filter elements**

Type	Material no. of filter element, filter rating in µm		
	H3XL	H6XL	PWR10
73.0110 .../G40-A00-0-M	R928052428	R928052434	R928047823
73.0120 .../G40-A00-0-M	R928052427	R928052433	R928047828
73.0135 .../G40-A00-0-M	R928052426	R928052432	R928047829
73.0145 .../G40-A00-0-M	R928052425	R928052431	R928036180
73.0200 .../G40-A00-0-M	R928052424	R928052430	R928036181
73.0270 .../G40-A00-0-M	R928052423	R928052429	R928036182

Filter design

Easy selection of the filter size is made possible by the FilterSelect online tool. The filter can be designed using the operating pressure, flow and fluid system parameters. The required filter rating is based on the application, the sensitivity to contamination of the components and the environmental conditions.

The program leads you through the menu on a step-by-step basis.

A documentation of the filter selection can finally be created in the form of a PDF file. This file contains the entered parameters, the designed filter with material number including spare parts, and the pressure loss curves.

Link FilterSelect:

<http://www.filterselect.de>

Other languages can be selected using the page navigation.

standard search

application: hydraulics for industrial use and applications with lubricating oil

Product category: please select

type: please select

pressure range: please select

filter material: please select

fineness: please select

volume flow rate: [l/min]

viscosity:
 * = working point

kin viscosity 1: 32 [mm²/s]

search via type of medium full-text search medium
 please select
 please select

temp 1: [°C] [°F] kin viscosity 1: [mm²/s]

dyn. Viscosity 1: [cP] density 1: [kg/dm³] kin viscosity 1: [mm²/s]

collapse pressure resistance according to ISO 2941: 30 bar

Function, set-up

The filter element is the central component of a filter. The actual filtration process takes part in the filter element. The main filter variables, such as retention capacity, dirt holding capacity and pressure loss are determined by the filter elements and the filter media used in them.

Hengst filter elements are used for the filtration of lubricants in wind turbines. The series 73. filter elements consist of two separate filter elements which are flown through one after the other.

In order to achieve the cleanliness class, the outer filter element (1) made of non-woven glass fiber media serves as the main filter. The inner filter element (2) made of wire mesh serves as a safety filter in case of a cold start. The outer filter element consists of a multi-layer combination of star-like pleated filter media which are laid around a perforated support tube. The inner filter element is set-up in the same way, except for the filter element mat.

The bypass valve (3) (see schematic) is situated in the filter cover of the filter housing.

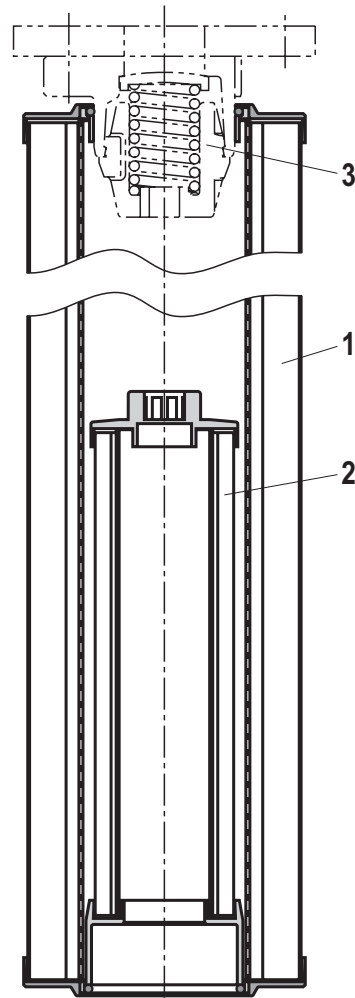

Possible operating conditions:

1. Normal operation with a clean filter element

The fluid flows through the outer filter element (1). The bypass valve is closed. When the fluid flows to the filter outlet, it passes the inner filter element (2).

2. Cold start or highly contaminated outer filter element

Only a very small portion of the fluid flows through the outer filter element (1). Almost the entire flow passes through the bypass valve, which is completely open. Through the open bypass valve (3), dirt particles get to the clean side of the outer filter element (1). But the inner filter element (2) still retains any coarse particles. Therefore, the downstream components are still protected, even under these conditions.

Filter variables

Filter rating and attainable oil cleanliness

The main goal when using industrial filters is not only the direct protection of machine components but to attain the required oil cleanliness.

Oil cleanliness is defined on the basis of oil cleanliness classes which classify how the amount of particles of the existing contamination is distributed in the operating liquid.

Filtration performance

Filtration ratio $\beta_{x(c)}$ (β value)

The retention capacity of hydraulic filters in a hydraulic system is characterized by the filtration ratio $\beta_{x(c)}$. This variable is therefore the most important performance characteristic of a hydraulic filter. It is measured in the multipass test and is the average value of the specified initial and final pressure differential according to ISO 16889 using ISOMTD test dust.

The filtration ratio $\beta_{x(c)}$ is defined as the ratio of the particle count of the respective particle size on both sides of the filter.

Dirt holding capacity

It is also measured using the multipass test and determines the amount of test dust ISOMTD which is fed to the filter medium until a specified pressure differential increase has been reached.

Pressure loss (also pressure differential or delta p)

The pressure loss of the filter element is the relevant characteristic value for the determination of the filter size. The pressure loss with a clean filter element is recommended by the filter manufacturer or defined by the system manufacturer. This characteristic value depends on many factors, mainly: the rating of the filter medium, its geometry and disposition in the filter element, the filter area, the operating viscosity of the fluid and the flow. The term "delta p" is often also expressed with the symbol " Δp ".

When dimensioning the filter, an initial pressure loss is determined which must not be exceeded by the new filter element based on the aforementioned conditions. The following diagram shows the typical pressure loss behavior of filter elements with different filter media at different flows for a viscosity of 30 mm²/s [150 SUS].

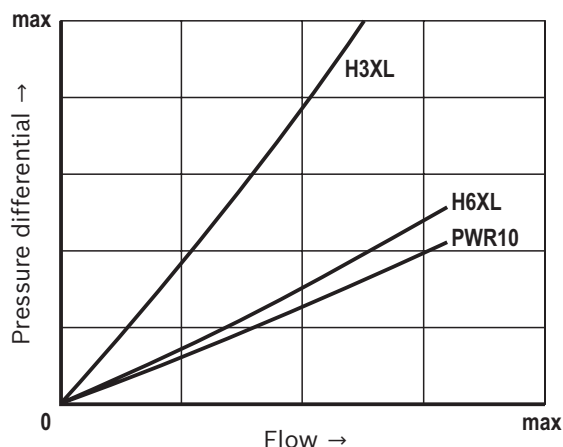
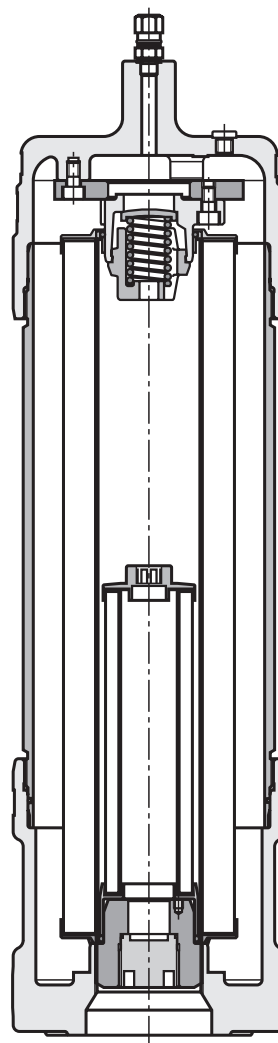

Filter media

Overview

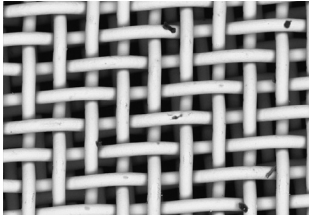
Filter medium/set-up	Electron microscope image
<p>PWR..., micro glass</p> <p>Glass fiber material generation 5 Configuration with a total of 6 layers consisting of 3 filter-efficient glass fiber layers, with electrically conductive non-woven media by default.</p>	
<p>G..., stainless steel wire mesh material 1.4401 or 1.4571</p> <p>Surface filter made of stainless steel wire mesh with supporting mesh.</p>	

Technical data

(For applications outside these parameters, please consult us!)

general				
Ambient temperature range	°C [°F]	-40 ... +50 [-40 ... +122]		
Weight	NG	0110	0120	0135
	kg [lbs]	1.9 [4.2]	3.3 [7.2]	3.7 [8.1]
	NG	0145	0200	0270
	kg [lbs]	3.7 [8.1]	4.3 [9.4]	6 [13]
Material	▶ Cover	Steel (tin-coated)		
	▶ Base	Aluminum		
	▶ Support tube	Steel (tin-coated)		
	▶ Filter material	Non-woven glass fiber media/stainless steel wire mesh		
	▶ Seal	NBR		
hydraulic				
Fluid temperature range	°C [°F]	-10 ... +100 [+14 ... +212] (for short periods down to -20 [-4])		
Minimum conductivity of the medium	pS/m	300		
Filtration direction		From the outside to the inside		

Filter media

Technical data

Non-woven glass fiber media, PWR...

If the Hengst PWR... filter medium is professionally designed and applied, it achieves a high degree of cleanliness for lubricants. Due to its defined retention capacity (ISO 16889), it offers highly effective protection for machine and system components which are sensitive to contamination.

- ▶ PWR... depth filter made of inorganic glass fiber material
- ▶ Absolute filtration/defined retention capacity according to ISO 16889
- ▶ High dirt holding capacity due to multi-layer set-up
- ▶ Non-reusable filter (not cleanable due to the depth filtration effect)
- ▶ Attainable oil cleanliness classes according to ISO 4406 up to ISO code 12/8/3 and better

Filter rating and attainable oil cleanliness

Recommended oil cleanliness according to ISO 4406 [SAE-AS 4059]	Recommended filter medium
≤ 18/13/10 (5)	H3XL
≤ 19/14/11 (6)	H6XL
≤ 20/16/13 (8)	PWR10

Filtration ratio $\beta_{x(c)}$ (β value)

Typical β values of up to 2.2 bar [31.9 psi] Δp pressure increase at the filter element ¹⁾

Filter medium	Particle size "x" for different β values, measurement according to ISO 16889		
	$\beta_{x(c)} \geq 75$	$\beta_{x(c)} \geq 200$	$\beta_{x(c)} \geq 1000$
H3XL	4.0 $\mu\text{m}(c)$	< 4.5 $\mu\text{m}(c)$	5.0 $\mu\text{m}(c)$
H6XL	4.8 $\mu\text{m}(c)$	5.5 $\mu\text{m}(c)$	7.5 $\mu\text{m}(c)$
PWR10	7.5 $\mu\text{m}(c)$	8.5 $\mu\text{m}(c)$	10.5 $\mu\text{m}(c)$

¹⁾ Filtration ratio $\beta_{x(c)}$ for other filter media upon request

Filtration ratio $\beta_{x(c)}$ dependent on particle size $\mu\text{m}(c)$

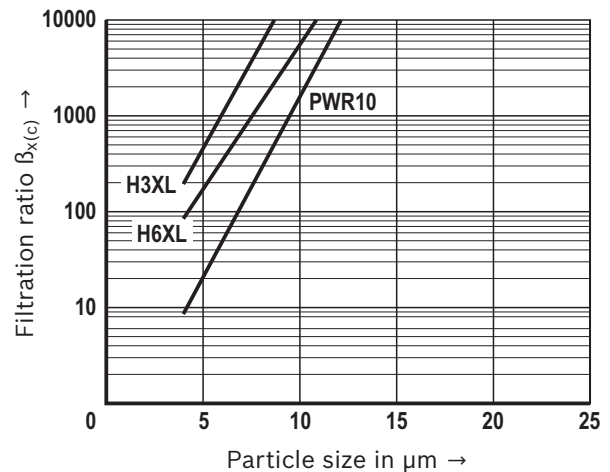

Filter media

Dirt holding capacity according to ISO 16889.

Compared to conventional filter media with single layer technology, the PWR... filter material features a high dirt holding capacity because it is made of three separate filter layers connected in series.

Conventional filter element (single-layer glass fiber material) - - - - -

Two-layer filter element (former H...XL material combination) - - - - -

Hengst PWR... filter element (three-layer glass fiber material with electrically conductive non-woven media) —————

Comparison of typical dirt holding capacities of glass fiber filter elements

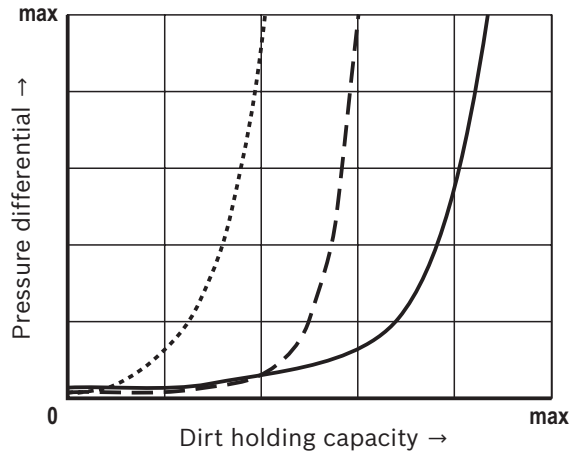

Stainless steel wire mesh, G...

Wire mesh G25 – G40

Filter medium	Design	Mesh size	Attainable oil cleanliness ¹⁾
G25	Woven mesh	25 µm nom.	no details, only suitable for coarse filtration (particle size ≥ 25 µm)
G40	Woven mesh	40 µm nom.	

¹⁾ according to ISO 4406 for particles ≥ 4 µm(c), ≥ 6 µm(c) and ≥ 14 µm(c)

Compatibility with hydraulic fluids

Hydraulic fluid	Classification	Suitable sealing materials	Standards
Mineral oil	HLP	NBR	DIN 51524
Bio-degradable ▶ Insoluble in water	HETG	NBR	VDMA 24568
Flame-resistant ▶ Containing water	HFAS, HFAE	NBR	DIN 24320
	HFC	NBR	VDMA 24317

Important information on hydraulic fluids:

- ▶ For further information and data on the use of other hydraulic fluids refer to data sheet 90220 or contact us!
- ▶ **Flame-resistant - containing water:** due to possible chemical reactions with materials or surface coatings of machine or system components, the service life with these hydraulic fluids may be

less than expected. Filter materials made of filter paper P... (cellulose) may not be used, filter elements with glass fiber filter material (PWR... or wire mesh G) have to be used instead.

- ▶ **Bio-degradable:** If filter materials made of filter paper P... are used instead of PWR..., the filter life may be shorter than expected due to material incompatibility and swelling.

Installation, commissioning and maintenance

When must the filter element be exchanged?

As soon as the dynamic pressure or the pressure differential set at the maintenance indicator is reached, the red pushbutton of the mechanical/visual maintenance indicator pops out. If an electronic switching element is provided, an electric signal will moreover sound. In this case, the filter element has to be replaced. Filter elements should be replaced after 6 months at the latest.

Notice:

Depending on the design of the filter size, the maintenance indicator may reach the set dynamic pressure or pressure differential during start-up of the hydraulic system. In this case, the optical-mechanical indicator must be manually acknowledged. The electric signal will stop after the operating temperature has been reached.

If the maintenance indicator is disregarded, the disproportionally increasing pressure differential may damage the filter element (collapse).

Filter element exchange

- ▶ Switch off the system and discharge the filter on the pressure side.

WARNING!

- ▶ Filters are containers under pressure. Before opening the filter housing, check whether the system pressure in the filter has been decreased to ambient pressure. Only then may the filter housing be opened for maintenance. Detailed instructions with regard to the filter element exchange can be found on the data sheet of the relevant filter series.

Directives and standardization

Product validation

Hengst filter elements are tested and quality-monitored according to different ISO test standards:

Filtration performance test (multipass test)	ISO 16889:2008-06
Δp (pressure loss) characteristic curves	ISO 3968:2001-12
Compatibility with hydraulic fluid	ISO 2943:1998-11
Collapse pressure test	ISO 2941:2009-04
Fluid Technology; Hydraulic Filter – Part 2; Assessment Criteria and Requirements	DIN 24550-2:2006-09

The development, manufacture and assembly of Hengst industrial filters and Hengst filter elements is carried out within the framework of a certified quality management system in accordance with ISO 9001:2015.

Notes

Hengst Filtration GmbH
Hardtwaldstr. 43
68775 Ketsch, Germany
Phone +49 (0) 62 02 / 6 03-0
hydraulicfilter@hengst.de
www.hengst.com

© This document, as well as the data, specifications and other information set forth in it, are the exclusive property of Hengst Filtration GmbH. It may not be reproduced or given to third parties without consent of Hengst Filtration GmbH. The data specified above only serve to describe the product. No statements concerning a certain condition or suitability for a certain application can be derived from our information. The information given does not release the user from the obligation of own judgment and verification. It must be remembered that our products are subject to a natural process of wear and aging.